

# Raccorderia con ghiera per Tape

per tubi in PE di spessore da 0.15 a 0.65 mm (da 6 a 25 mil)

*Tape pipe fittings with nut*

*for PE pipes with thickness from 0.15 to 0.65 mm (from 6 to 25 mil)*

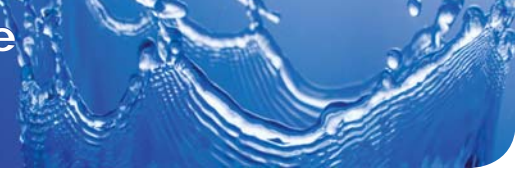

## CARATTERISTICHE TECNICHE TECHNICAL FEATURES

MATERIALI IMPIEGATI / RAW MATERIALS	PP + anti-UV
PRESSIONE DI ESERCIZIO / WORKING PRESSURE	MAX 4 bar - 20°C
TEMPERATURA MAX / MAXIMUM TEMPERATURE	80°C
FILETTATURE / THREAD	BSPT / NPT / HT

I dati del presente catalogo, hanno titolo puramente indicativo e non sono vincolanti. La Plast Project S.r.l. si riserva il diritto, anche senza preavviso, di effettuare modifiche ai prodotti, ai fini del loro miglioramento tecnico.

*The specifications in this document are to be considered merely informative and are not binding. Plast Project S.r.l. reserves its right to carry out all the modifications which are considered necessary in accordance with technical improvement.*

# Raccorderia con ghiera per Tape

per tubi in PE di spessore da 0.15 a 0.65 mm (da 6 a 25 mil)

*Tape pipe fittings with nut*

for PE pipes with thickness from 0.15 to 0.65 mm (from 6 to 25 mil)



## 3610

CODE	Ø	LT	F	D	LO	LA	FG
3610.0095	9.5-9.5	78.8	5.9	9.6	3.5	24.0	9.3
3610.0170	17-17	80.8	11.8	16.9	3.5	36.8	16.6
3610.0220	22-22	82.8	15.9	22.3	3.5	45.5	22.0

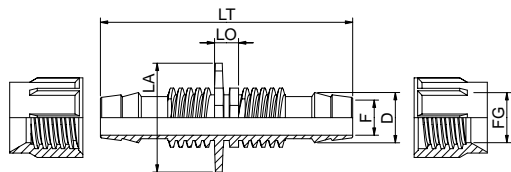

## 3615

CODE	Ø	LT	F	D	FR	DR	LO	LA	FG	FGR
3615.1795	17-9.5	79.8	11.8	16.9	5.9	9.6	3.5	36.8	16.6	9.3
3615.2217	22-17	81.8	15.9	22.3	11.8	16.9	3.5	45.5	22.0	16.6

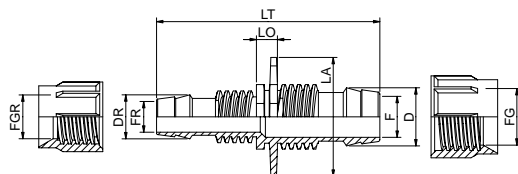

## 3620

CODE	Ø	LT	F	D	FF	DF	LF	LO	FG
3620.095C	9.5-1/2"	60.7	5.9	9.6	14.0	1/2"	15.3	8.0	9.3
3620.095D	9.5-3/4"	64.6	5.9	9.6	18.3	3/4"	17.3	10.0	9.3
3620.017C	17-1/2"	61.7	11.8	16.9	14.0	1/2"	15.3	8.0	16.6
3620.017D	17-3/4"	65.6	11.8	16.9	18.3	3/4"	17.3	10.0	16.6
3620.022C	22-1/2"	62.7	15.9	22.3	14.0	1/2"	15.3	8.0	22.0
3620.022D	22-3/4"	66.6	15.9	22.3	18.3	3/4"	17.3	10.0	22.0

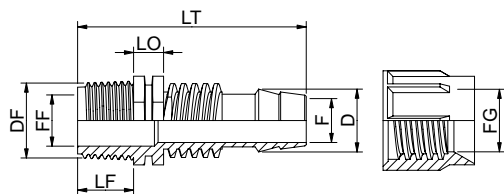

## 3628

CODE	Ø	LT	F	D	FD	DG	DT	LA	FG
3628.0095	9.5-D	53.5	5.9	9.6	5.9	8.8	11.2	24.0	9.3

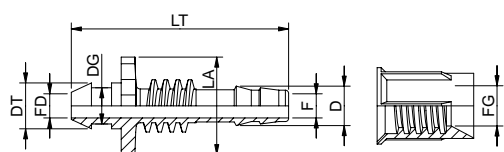

# Raccorderia con ghiera per Tape

per tubi in PE di spessore da 0.15 a 0.65 mm (da 6 a 25 mil)

*Tape pipe fittings with nut*

for PE pipes with thickness from 0.15 to 0.65 mm (from 6 to 25 mil)



## 3635

CODE	Ø	LT	F	D	FD	DC	DT	LO	LA	FG
3635.0095	9.5-D	57.1	5.9	9.6	8.9	14.0	16.8	3.5		9.3
3635.0170	17-D	58.1	11.8	16.9	8.9	14.0	16.8	3.5	36.8	16.6
3635.0220	22-D	59.1	15.9	22.3	8.9	14.0	16.8	3.5	45.5	22.0

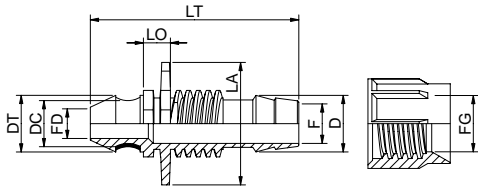

## 3637

CODE	Ø	LT	F	D	FD	DC	DT	LO	LA	FG
3637.0220	22-DXL	66.8	15.9	22.3	14.0	19.0	21.8	8.0	45.5	22.0

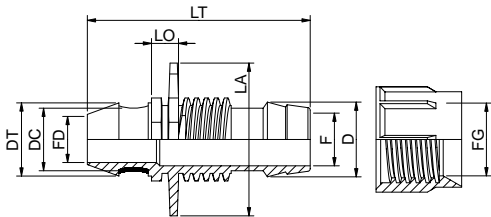

## 3644

CODE	Ø	LT	F	D	FD	DG	DT	LO	LA	FG
3644.0170	17-D	60.2	11.8	16.9	8.9	11.8	14.0	3.5	36.8	16.6
3644.0220	22-D	61.3	15.9	22.3	8.9	11.8	14.0	3.5	45.5	22.0

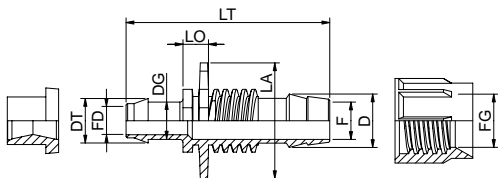

## 3645

CODE	Ø	LT	F	D	FD	DG	DT	LF	LO	LA	FG
3645.0095	9.5-D	75.2	5.9	9.6	7.9	11.4	14.0	14.0	3.5		9.3
3645.0170	17-D	76.2	11.8	16.9	7.9	11.4	14.0	14.0	3.5	36.8	16.6
3645.0220	22-D	77.2	15.9	22.3	7.9	11.4	14.0	14.0	3.5	45.5	22.0

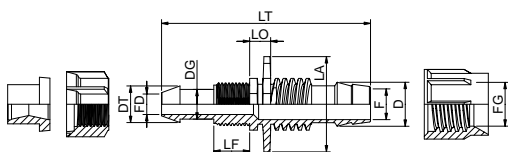

# Raccorderia con ghiera per Tape

per tubi in PE di spessore da 0.15 a 0.65 mm (da 6 a 25 mil)

*Tape pipe fittings with nut*

for PE pipes with thickness from 0.15 to 0.65 mm (from 6 to 25 mil)



## 3650

CODE	Ø	LT	F	D	DF	DE	LF	LO	LV	FG
3650.0170	17-D	66.3	11.8	16.9	3/8"	24.3	19.3	10.0	49.6	16.6
3650.0220	22-D	67.3	15.9	22.3	3/8"	24.3	19.3	10.0	49.6	22.0

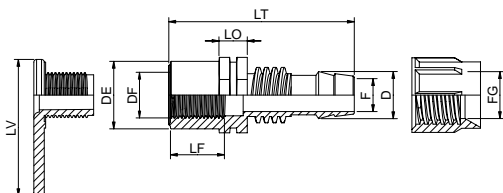

## 3655

CODE	Ø	LT	F	D	DF	DE	LV	DG	LG	FG
3655.0170	17-D	66.3	11.8	16.9	3/8"	29.3	49.6	30.0	21.2	16.6

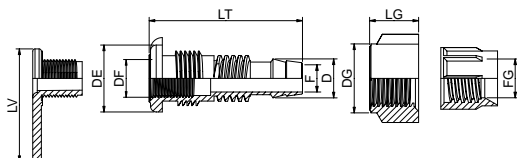

## 3660

CODE	Ø	LT	F	D	LO	LA	FG
3660.0095	9.5						
3660.0170	17	48.5	11.8	16.9	8.0	36.8	16.6
3660.0220	22	49.5	15.9	22.3	8.0	45.5	22.0

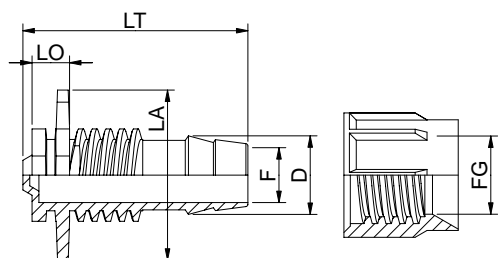

## 3665

CODE	Ø	LT	F	D	F1	D1	LO	LA	FG	FG1
3665.1617	16-17	84.2	11.8	16.9	9.9	16.0	8.0	36.8	16.6	16.3
3665.1817	18-17	84.2	11.8	16.9	11.8	18.0	8.0	36.8	16.6	18.3
3665.2017	20-17	85.2	11.8	16.9	14.0	20.0	8.0	40.8	16.6	21.0
3665.2217	22-17	86.1	11.8	16.9	17.6	23.5	8.0	45.5	16.6	24.3
3665.1622	16-22	85.2	15.9	22.3	9.9	16.0	8.0	45.5	22.0	16.3
3665.1822	18-22	85.2	15.9	22.3	11.8	18.0	8.0	45.5	22.0	18.3
3665.2022	20-22	86.2	15.9	22.3	14.0	20.0	8.0	45.5	22.0	21.0
3665.2222	22-22	87.1	15.9	22.9	17.6	23.5	8.0	45.5	22.0	24.3

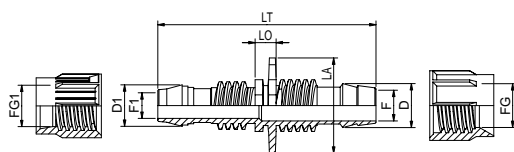

# Raccorderia con ghiera per Tape

per tubi in PE di spessore da 0.15 a 0.65 mm (da 6 a 25 mil)

*Tape pipe fittings with nut*

for PE pipes with thickness from 0.15 to 0.65 mm (from 6 to 25 mil)



## 3670

CODE	Ø	LT	F	D	F1	D1	D2	LO	LA	FG
3670.1609	16-9.5	69.3	5.9	9.6	9.8	14.8	15.6	3.5		9.3
3670.1617	16-17	70.3	11.8	16.9	9.8	14.8	15.6	3.5	36.8	16.6
3670.1622	16-22	71.3	15.9	22.3	9.8	14.8	15.6	3.5	45.5	22.0
3670.2017	20-17	76.8	11.8	16.9	13.9	19.0	20.0	8.0	36.8	16.6
3670.2022	20-22	77.8	15.9	22.3	13.9	19.0	20.0	8.0	45.5	22.0
3670.2517	25-17	75.3	11.8	16.9	18.2	24.0	25.0	3.5		16.6
3670.2522	25-22	77.8	15.9	22.3	18.2	24.0	25.0	8.0	45.5	22.0

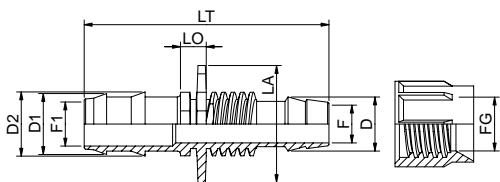

## 3675

CODE	Ø	LT	F	D	F1	D1	D2	LO	LA	FG	FG1
3675.1617	16-17	74.2	11.8	16.9	10.0	14.2	15.0	3.5	36.8	16.6	16.7
3675.1622	16-22	75.2	15.9	22.3	10.0	14.2	15.0	3.5	45.5	22.0	16.7
3675.2017	20-17	75.9	11.8	16.9	14.0	18.3	19.1	3.5	36.8	16.6	20.7
3675.2022	20-22	76.8	15.9	22.3	14.0	18.3	19.1	3.5	45.5	22.0	20.7
3675.2517	25-17	84.2	11.8	16.9	18.3	23.1	23.9	10.0		16.6	25.7
3675.2522	25-22	83.2	15.9	22.3	18.3	23.1	23.9	8.0	45.5	22.0	25.7

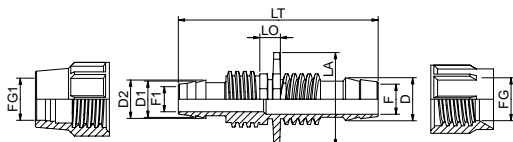

## 3710

CODE	Ø	LT	F	D	FG
3710.0170	17-17-17	108.8	11.8	16.9	16.6
3710.0220	22-22-22	110.8	15.9	22.3	22.0

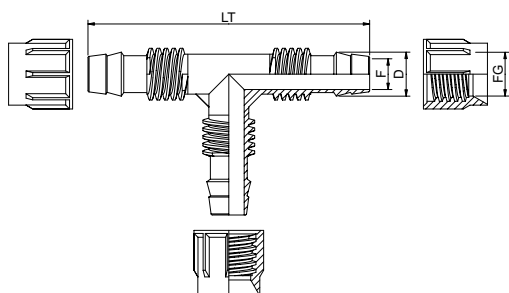

## 3715

CODE	Ø	LT	F	D	FR	DR	FG	FGR
3715.1722	22-17-22	110.8	15.9	22.3	11.8	16.9	22.0	16.6
3715.2217	17-22-17	108.8	11.8	16.9	15.9	22.3	16.6	22.0

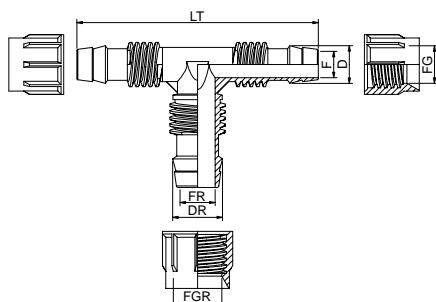

# Raccorderia con ghiera per Tape

per tubi in PE di spessore da 0.15 a 0.65 mm (da 6 a 25 mil)

*Tape pipe fittings with nut*

for PE pipes with thickness from 0.15 to 0.65 mm (from 6 to 25 mil)



## 3720

CODE	Ø	LT	F	D	FF	DF	LF	FG
3720.017C	17- $\frac{1}{2}$ "-17	108.8	11.8	16.9	14.0	$\frac{1}{2}$ "	15.3	16.6
3720.017D	17- $\frac{3}{4}$ "-17	108.8	11.8	16.9	18.3	$\frac{3}{4}$ "	17.3	16.9
3720.022C	22- $\frac{1}{2}$ "-22	110.8	15.9	22.3	14.0	$\frac{1}{2}$ "	15.3	22.0
3720.022D	22- $\frac{3}{4}$ "-22	110.8	15.9	22.3	18.3	$\frac{3}{4}$ "	17.3	22.0

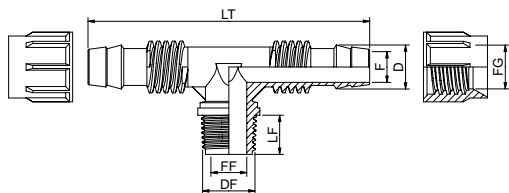

## 3735

CODE	Ø	LT	F	D	FD	DC	DT	FG
3735.0170	17-D-17	108.8	11.8	16.9	8.9	14.0	16.8	16.6
3735.0220	22-D-22	110.8	15.9	22.3	8.9	14.0	16.8	22.0

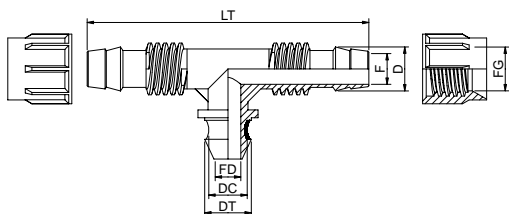

## 3737

CODE	Ø	LT	F	D	FD	DC	DT	FG
3737.0170	17-DXL-17	108.8	11.8	16.9	14.0	19.0	21.8	16.6
3737.0220	22-DXL-22	110.8	15.9	22.3	14.0	19.0	21.8	22.0

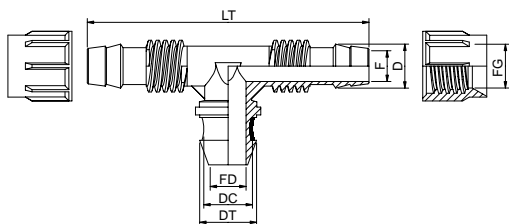

## 3765

CODE	Ø	LT	F	D	F1	D1	FG	FG1
3765.1617	17-16-17	108.8	11.8	16.9	9.9	16.0	16.6	16.3
3765.1622	22-16-22	110.8	15.9	22.3	9.9	16.0	22.0	16.3
3765.1817	17-18-17	108.8	11.8	16.9	11.8	18.0	16.6	18.3
3765.1822	22-18-22	110.8	15.9	22.3	11.8	18.0	22.0	18.3
3765.2017	17-20-17	108.8	11.8	16.9	14.0	20.0	16.6	21.0
3765.2022	22-20-22	110.8	15.9	22.3	14.0	20.0	22.0	21.0
3765.2217	17-22-17	108.8	11.8	16.9	17.6	23.5	16.6	24.3
3765.2222	22-22-22	110.8	15.9	22.3	17.6	23.5	22.0	24.3

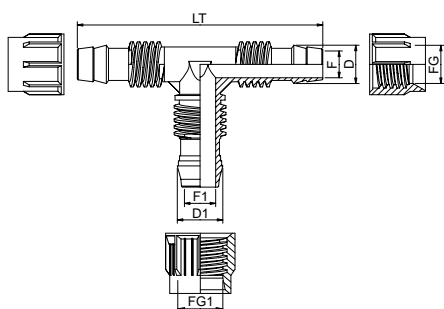

# Raccorderia con ghiera per Tape

per tubi in PE di spessore da 0.15 a 0.65 mm (da 6 a 25 mil)

*Tape pipe fittings with nut*

for PE pipes with thickness from 0.15 to 0.65 mm (from 6 to 25 mil)



## 3770

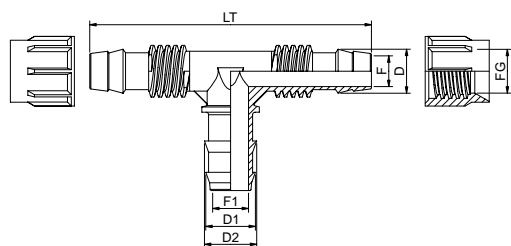

CODE	Ø	LT	F	D	F1	D1	D2	FG
3770.1617	17-16-17	108.8	11.8	16.9	9.8	14.8	15.6	16.6
3770.1622	22-16-22	110.8	15.9	22.3	9.8	14.8	15.6	22.0
3770.2017	17-20-17	108.8	11.8	16.9	13.9	19.0	20.0	16.6
3770.2022	22-20-22	110.8	15.9	22.3	13.9	19.0	20.0	22.0
3770.2517	17-25-17	108.8	11.8	16.9	18.2	24.0	25.0	16.6
3770.2522	22-25-22	110.8	15.9	22.3	18.2	24.0	25.0	22.0

## 3775

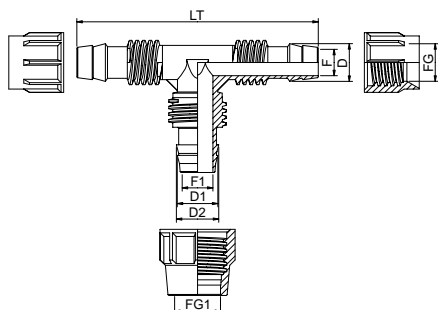

CODE	Ø	LT	F	D	F1	D1	D2	FG	FG1
3775.1617	17-16-17	108.8	11.8	16.9	10.0	14.2	15.0	16.6	16.7
3775.1622	22-16-22	110.8	15.9	22.3	10.0	14.2	15.0	22.0	16.7
3775.2017	17-20-17	108.8	11.8	16.9	14.0	18.3	19.1	16.6	20.7
3775.2022	22-20-22	110.8	15.9	22.3	14.0	18.3	19.1	22.0	20.7
3775.2517	17-25-17	108.8	11.8	16.9	18.3	23.1	23.9	16.6	25.7
3775.2522	22-25-22	110.8	15.9	22.3	18.3	23.1	23.9	22.0	25.7

## 3810 / 3815

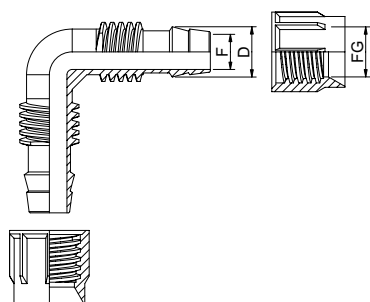

CODE	Ø	F	D	FG	FR	DR	FGR
3810.0170	17-17	11.8	16.9	16.6			
3810.0220	22-22	15.9	22.3	22.0			
3815.2217	22-17	15.9	22.3	22.0	11.8	16.9	16.6

## 3820

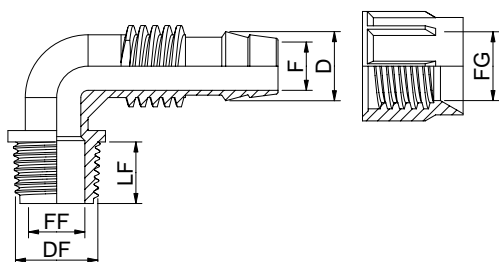

CODE	Ø	F	D	FF	DF	LF	FG
3820.017C	17-1/2"	11.8	16.9	14.0	1/2"	15.3	16.6
3820.017D	17-3/4"	11.8	16.9	18.3	3/4"	17.3	16.6
3820.022C	22-1/2"	15.9	22.3	14.0	1/2"	15.3	22.0
3820.022D	22-3/4"	15.9	22.3	18.3	3/4"	17.3	22.0

# Raccorderia con ghiera per Tape

per tubi in PE di spessore da 0.15 a 0.65 mm (da 6 a 25 mil)

*Tape pipe fittings with nut*

for PE pipes with thickness from 0.15 to 0.65 mm (from 6 to 25 mil)



## 3835

CODE	Ø	F	D	FD	DC	DT	FG
3835.0170	17-D	11.8	16.9	8.9	14.0	16.8	16.6
3835.0220	22-D	15.9	22.3	8.9	14.0	16.8	22.0

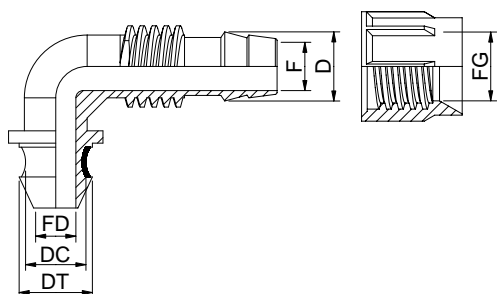

## 3837

CODE	Ø	F	D	FD	DC	DT	FG
3837.0170	17-DXL	11.8	16.9	14.0	19.0	21.8	16.6
3837.0220	22-DXL	15.9	22.3	14.0	19.0	21.8	22.0

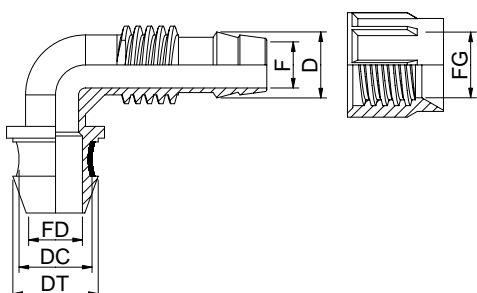

## 3865

CODE	Ø	F	D	F1	D1	FG	FG1
3865.1617	16-17	11.8	16.9	9.9	16.0	16.6	16.3
3865.1622	16-22	15.9	22.3	9.9	16.0	22.0	16.3
3865.1817	18-17	11.8	16.9	11.8	18.0	16.6	18.3
3865.1822	18-22	15.9	22.3	11.8	18.0	22.0	18.3
3865.2017	20-17	11.8	16.9	14.0	20.0	16.6	21.0
3865.2022	20-22	15.9	22.3	14.0	20.0	22.0	21.0
3865.2217	22-17	11.8	16.9	17.6	23.5	16.6	24.3
3865.2222	22-22	15.9	22.3	17.6	23.5	22.0	24.3

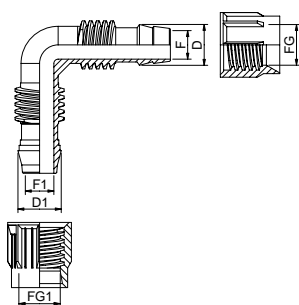

## 3870

CODE	Ø	F	D	F1	D1	D2	FG
3870.1617	16-17	11.8	16.9	9.8	14.8	15.6	16.6
3870.1622	16-22	15.9	22.3	9.8	14.8	15.6	22.0
3870.2017	20-17	11.8	16.9	13.9	19.0	20.0	16.6
3870.2022	20-22	15.9	22.3	13.9	19.0	20.0	22.0
3870.2517	25-17	11.8	16.9	18.2	24.0	25.0	16.6
3870.2522	25-22	15.9	22.3	18.2	24.0	25.0	22.0

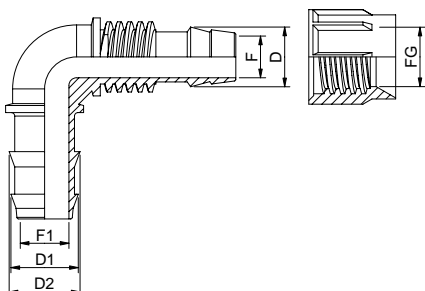



# Raccorderia con ghiera per Tape

per tubi in PE di spessore da 0.15 a 0.65 mm (da 6 a 25 mil)

*Tape pipe fittings with nut*

*for PE pipes with thickness from 0.15 to 0.65 mm (from 6 to 25 mil)*



**3875**

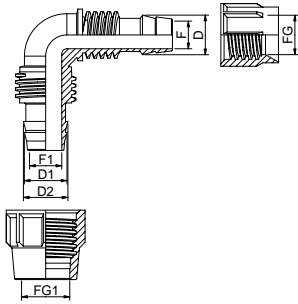

CODE	Ø	F	D	F1	D1	D2	FG	FG1
3875.1617	16-17	11.8	16.9	10.0	14.2	15.0	16.6	16.7
3875.1622	16-22	15.9	22.3	10.0	14.2	15.0	22.0	16.7
3875.2017	20-17	11.8	16.9	14.0	18.3	19.1	16.6	20.7
3875.2022	20-22	15.9	22.3	14.0	18.3	19.1	22.0	20.7
3875.2517	25-17	11.8	16.9	18.3	23.1	23.9	16.6	25.7
3875.2522	25-22	15.9	22.3	18.3	23.1	23.9	22.0	25.7